

HBsAg Test Positive

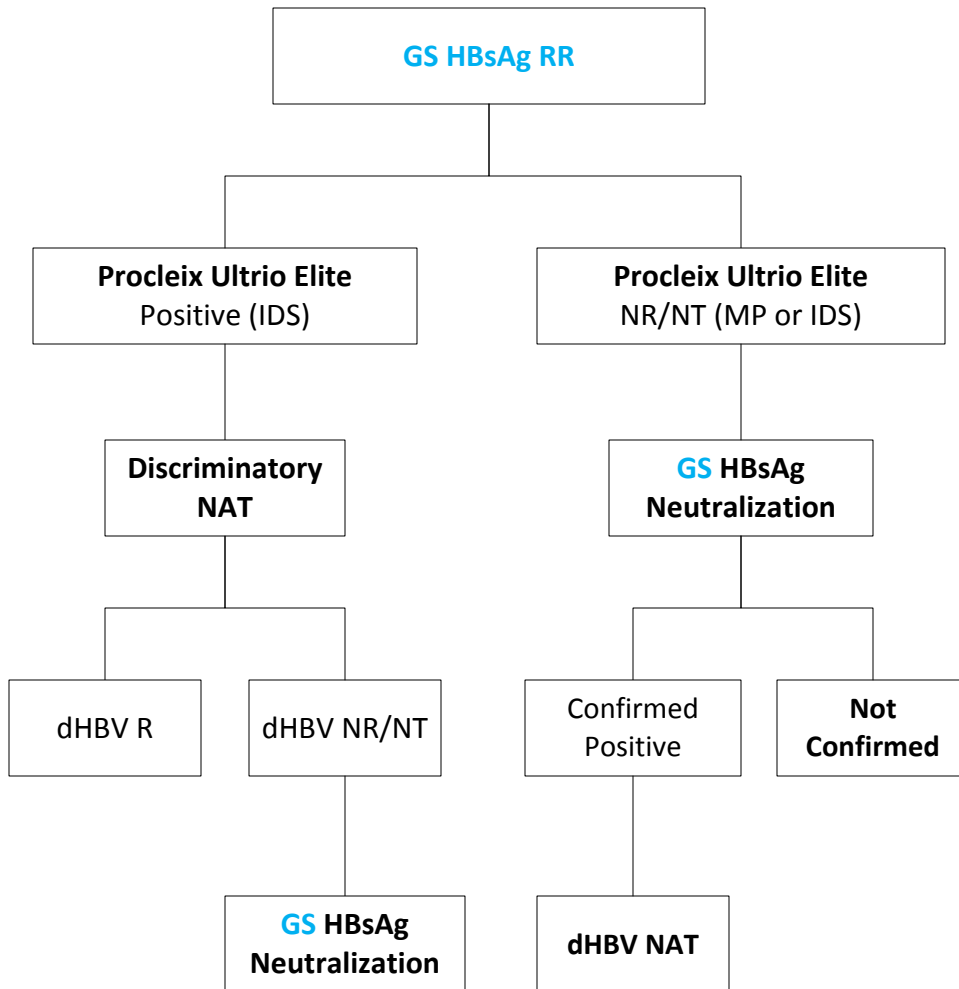

Anti-HBc Test Positive

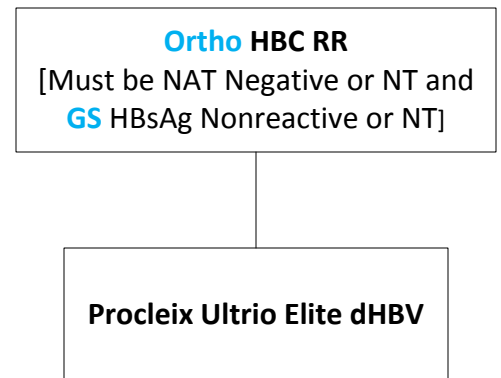

HBV NAT Yield

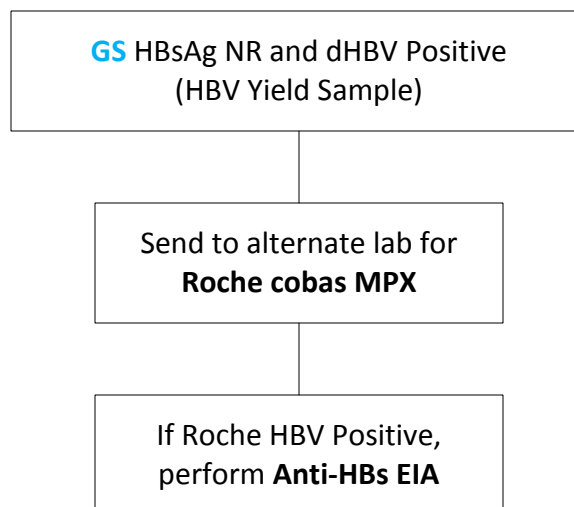

Anti-HCV Test Positive

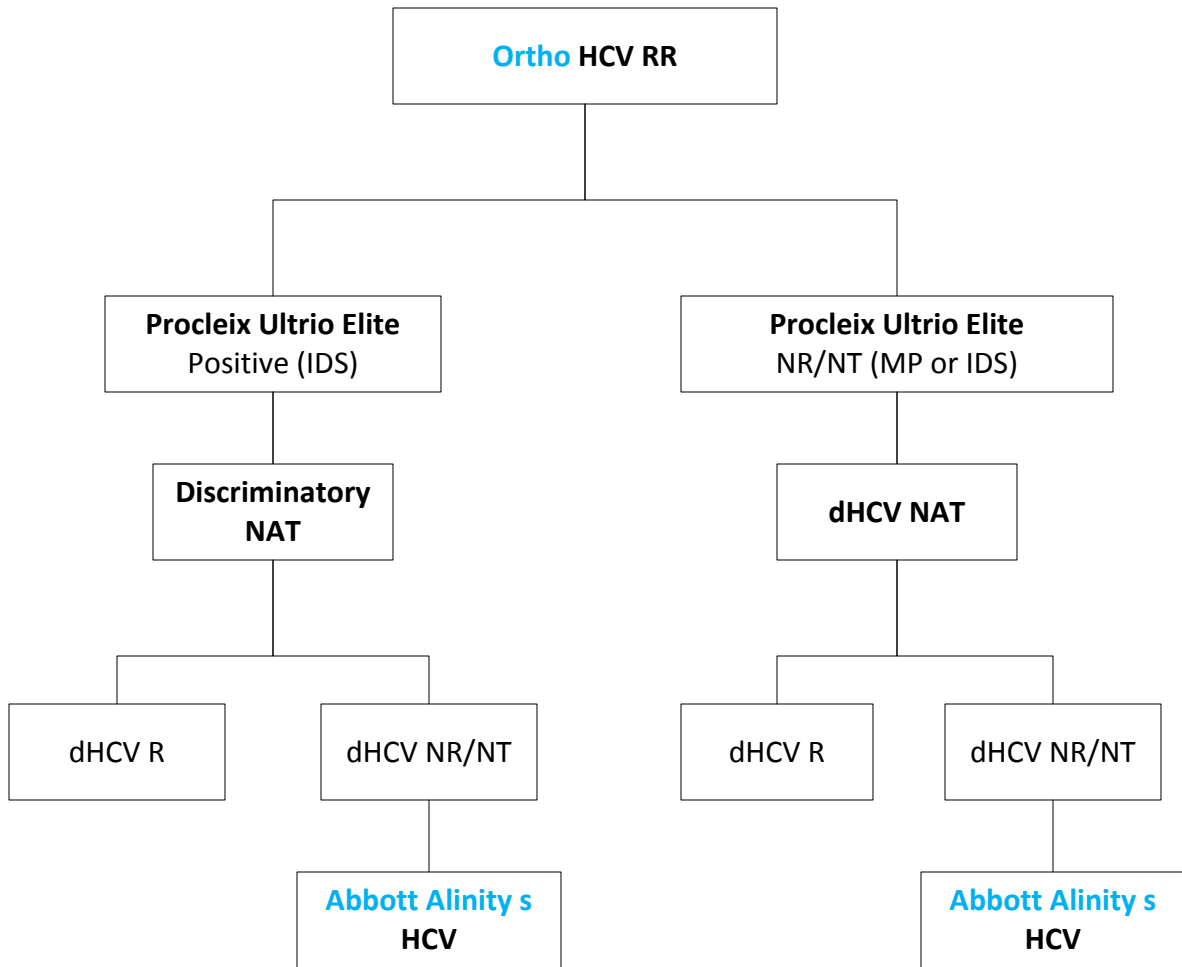

HCV NAT Yield

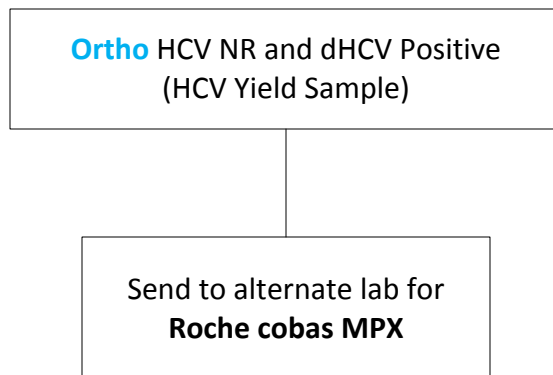

Anti-HIV Test Positive

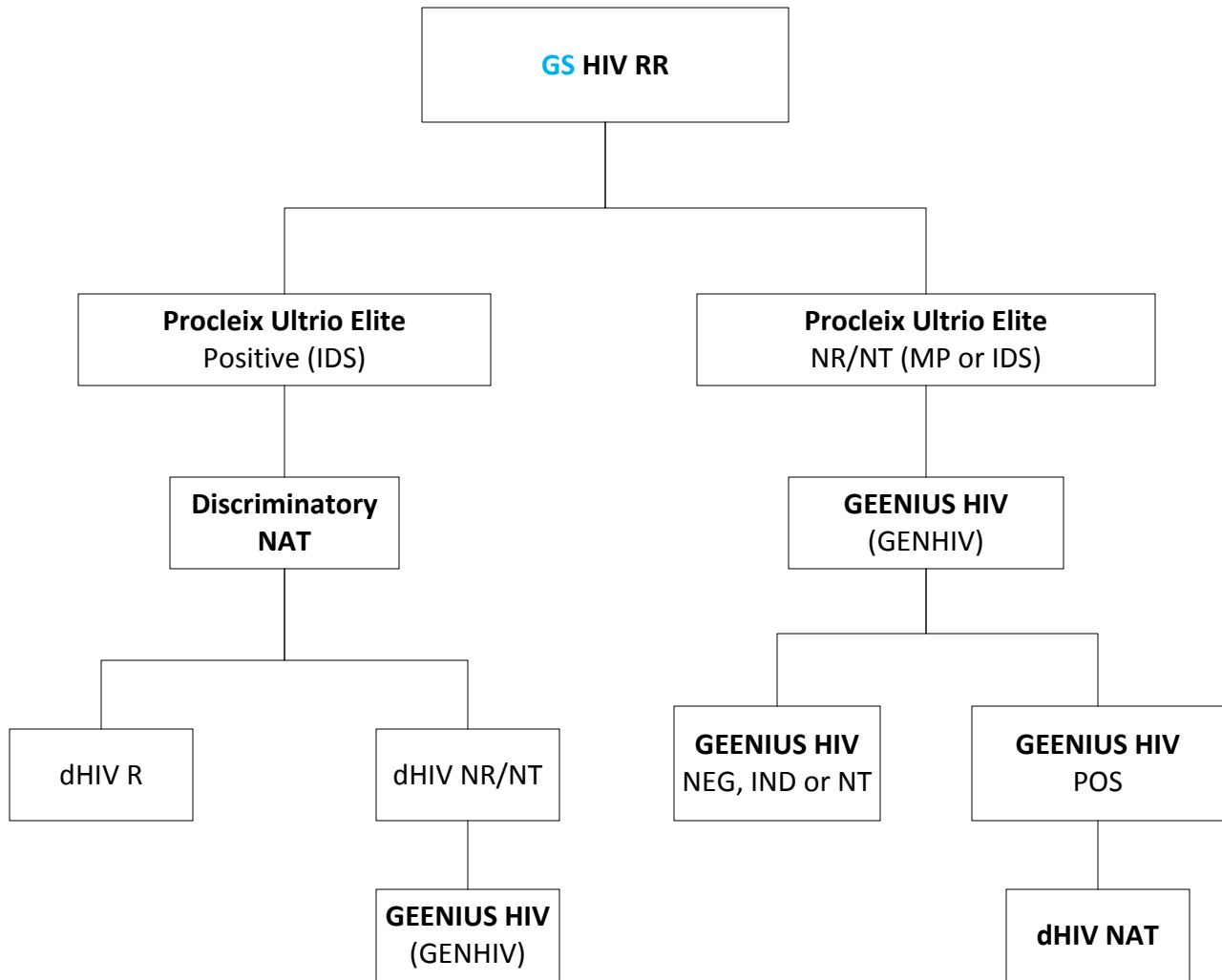

HIV NAT Yield

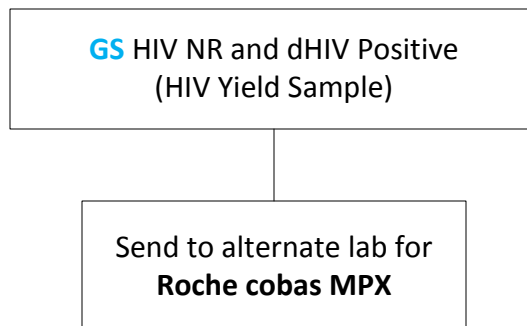

Anti-HTLV-I/II Test Positive

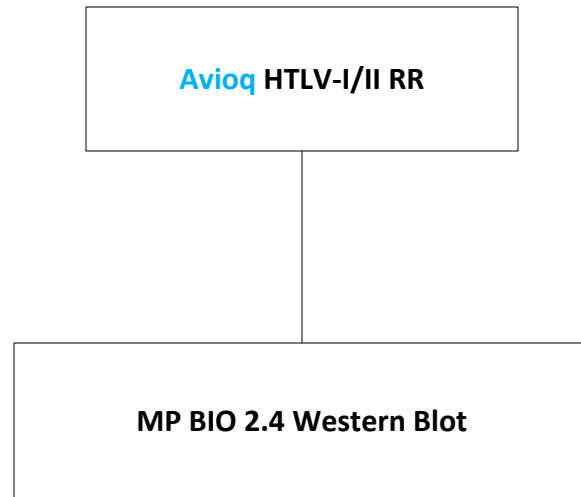

Anti-T. cruzi Test Positive

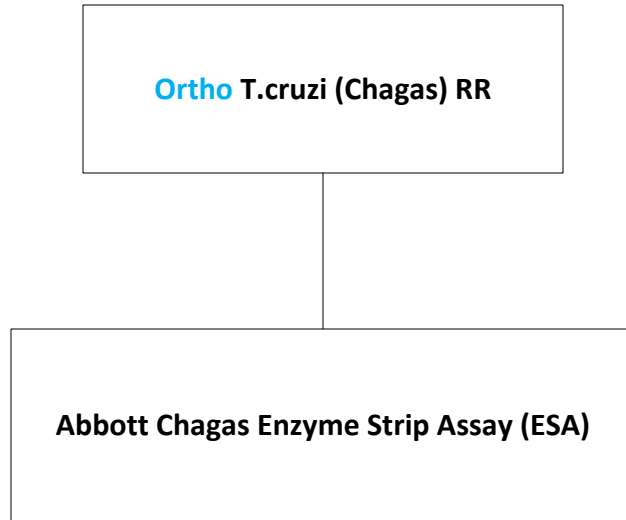

Syphilis Test Positive

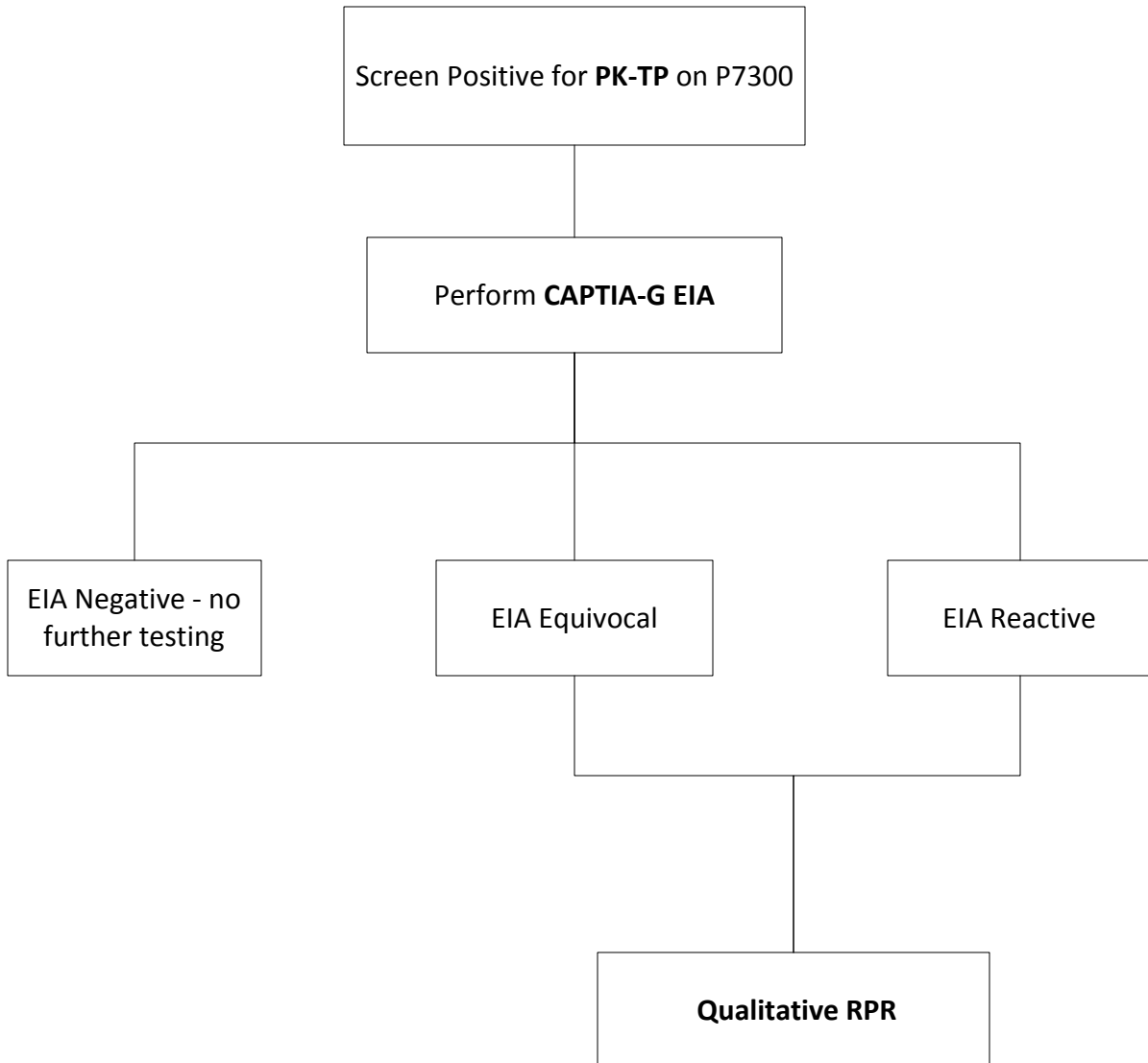

WNV NAT Test Positive

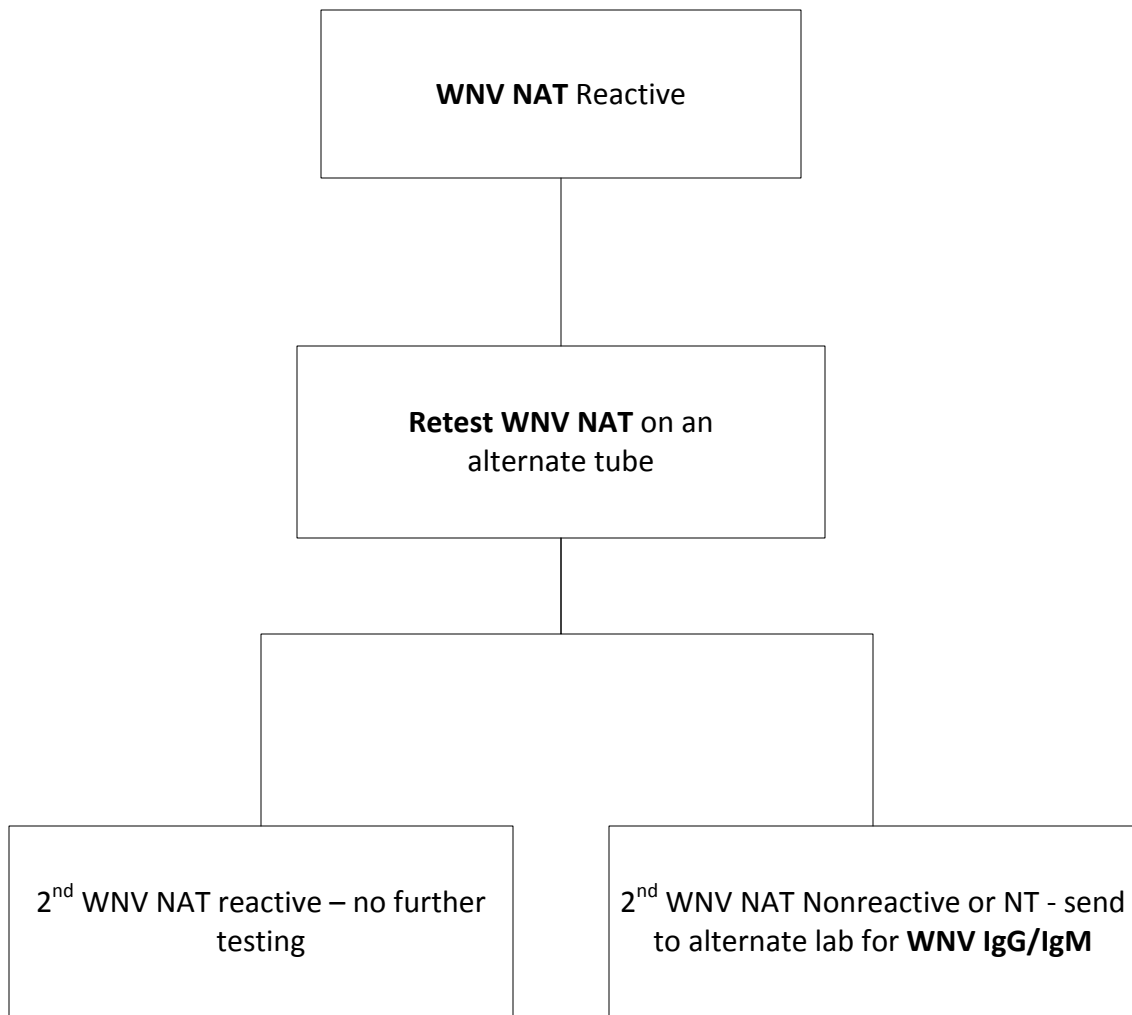

ZIKA NAT Test Positive

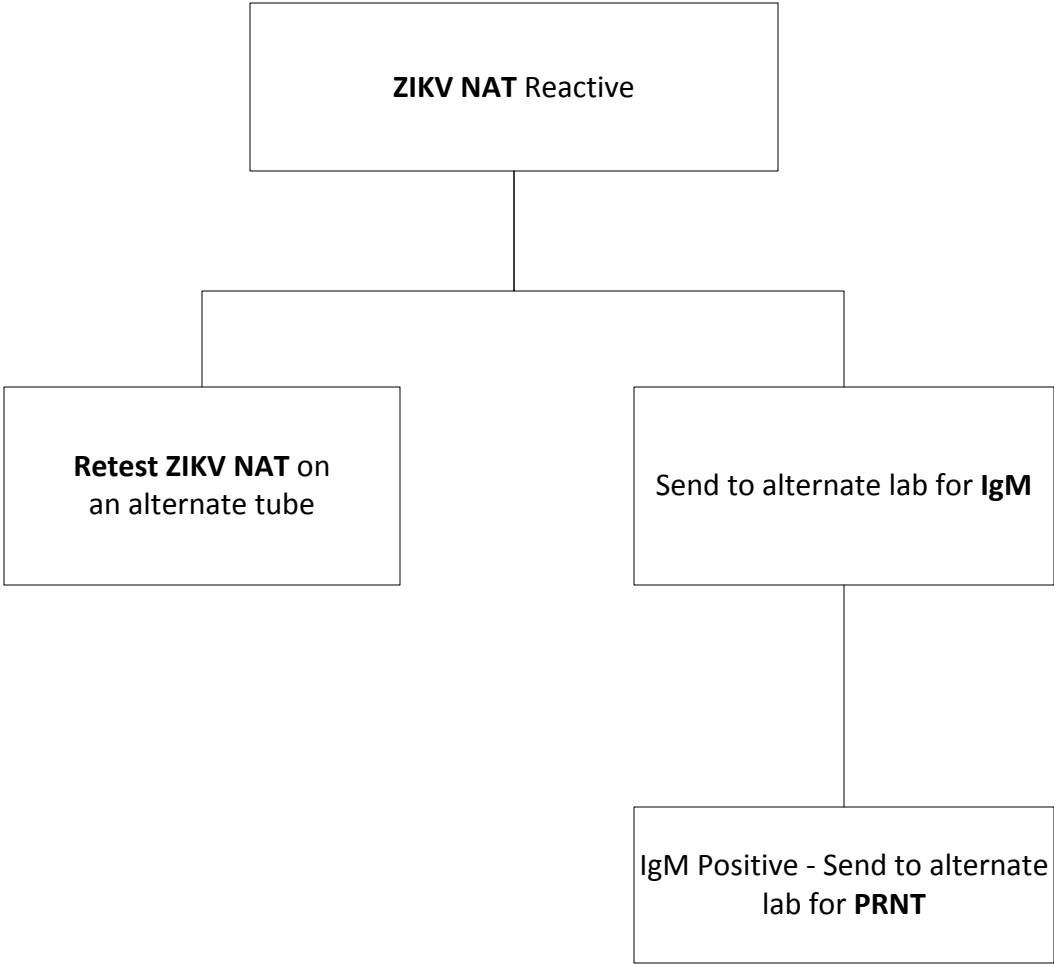

***Babesia* NAT Test Positive**

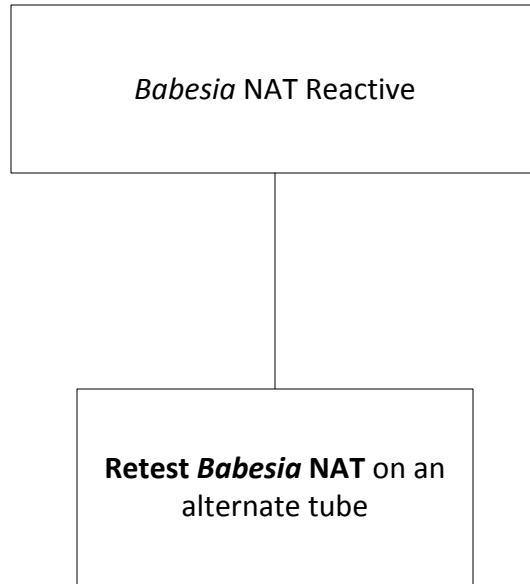

Rev 5 01/11/21	<ul style="list-style-type: none"> • Replacement of Prism HBsAg Neutralization with GS HBsAg Neutralization • Replacement of Ortho HCV reflex with Abbott Allinity s HCV reflex testing • Discontinuation of alternate <i>T. cruzi</i> screening test for ESA Chagas positives
Rev 4 09/21/20	<ul style="list-style-type: none"> • Replacement of HIV-1 Western blot and Anti-HIV-2 EIA with Geenius HIV 1/2 Supplemental Assay • Removal of SARS-CoV-2 testing (relocated to a separate document)
Rev 3 07/07/20	<ul style="list-style-type: none"> • Replacement of Ultrio Plus with Ultrio Elite • Addition of SARS-CoV-2 testing
Rev 2 04/20/20	<ul style="list-style-type: none"> • HCV reflex to dHCV with alternate manufacturer screen (Ortho ELISA) only if dHCV NR/NT • Addition of Babesia NAT • Modification of HBsAg and HIV flowchart formatting for consistency (no change to testing performed)
Rev 1 09/30/19	<ul style="list-style-type: none"> • Discontinuation of HIV-1 IFA, replacement with HIV-1 WB • HBc reflex to dHBV for HBc RR, NAT NR, HBsAg NR • Conversion from Roche MPX 2.0 to Roche cobas MPX • Anti-HBs for HBV NAT yield donations
12/17/18	<ul style="list-style-type: none"> • Original release; standard consolidated CTS algorithm